

HS-100B Technical Data Sheet

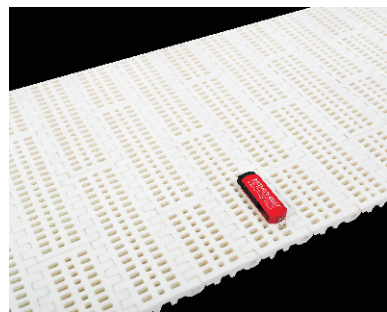
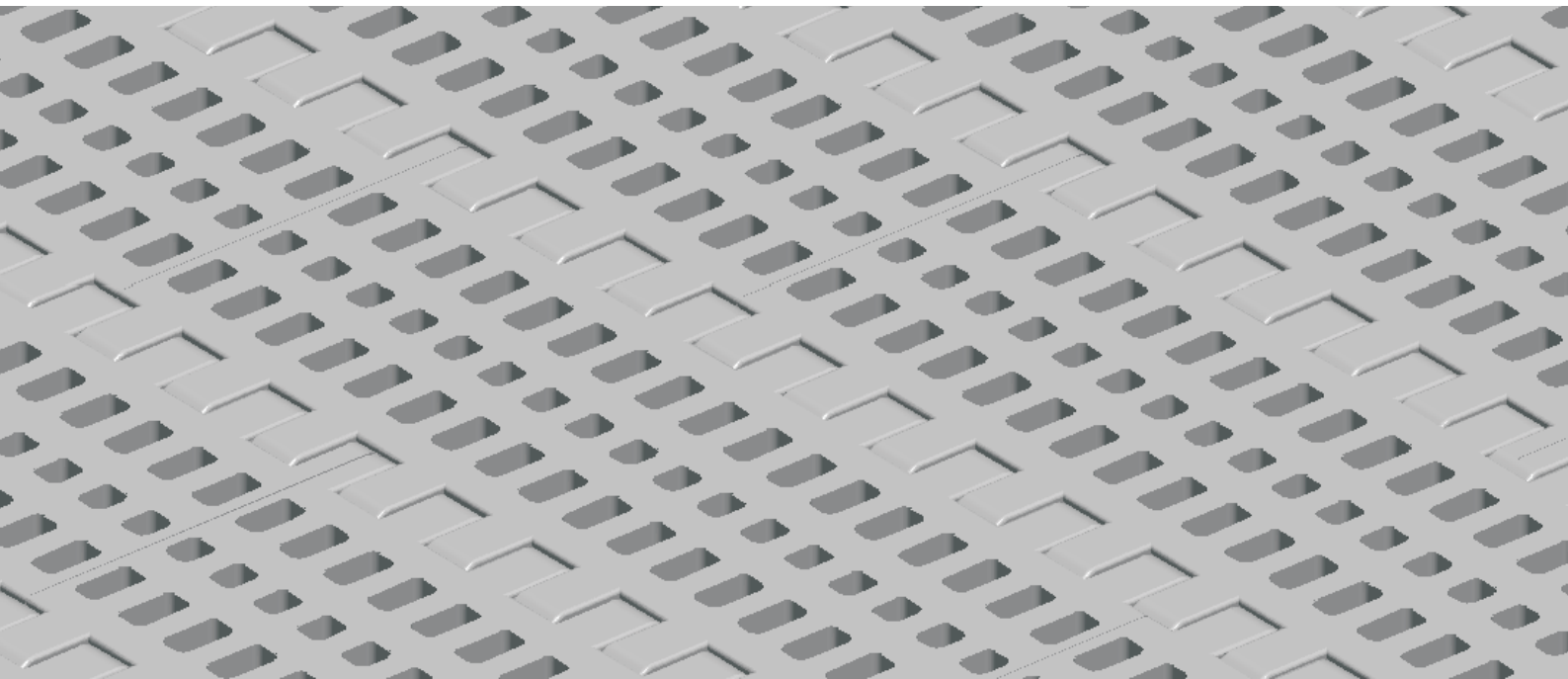

<p>Pitch: 50.8mm Minimum Width: 45mm Open Area: 20% Approved: FDA Rod: Ø 5.8mm Flight: Yes Side Guard: Yes Curve: No</p>	
---	--

Data

Belt Material	Belt Strength			Temperature		Belt Weight (Kg/M ²)
	Straight		Curve	°C (min.)	°C (max.)	
	Kg/M(BW)	N/M(BW)				
Polypropylene	1340	13400	--	1	100	7.5
Polyethylene	1280	12800	--	-60	60	8.7
Acetal	1770	17700	--	-40	80	10.2
Nylon	1520	15200	--	1	180	9.6

BW – Belt Width

Color Table

Polypropylene					Polyethylene					Acetal					Nylon				
W	G	N	DB	B	W	G	N	DB	B	W	G	N	DB	B	W	G	N	DB	B
●	●						●			●	●					●			

W-White, G-Gray, N-Nature, DB-Dark brown, B-Blue (For more information of belt color, pls consult our sales team)

Friction Table

Belt Material	Friction Wear strips & Products							
	UHMW	HDPE	Steel	Glass	SUS	Plastic	Cardboard	Aluminum
Polypropylene	0.32	0.24	0.15	0.09	0.13	0.08	0.15	0.25
Polyethylene	0.13	0.11	0.26	0.19	0.31	0.16	0.21	0.41
Acetal	0.11	0.09	0.27	0.16	0.26	0.15	0.19	0.28
Nylon	0.18	0.13	0.25	0.16	0.26	0.16	0.19	0.27

SUS – Stainless Steel

Equivalent type with other Brand

Brand Name	Intralox	Habasit	UNI	Rexnord	MCC	ScanBelt
Series & Type	--	--	--	--	--	--

The above content is only for reference.

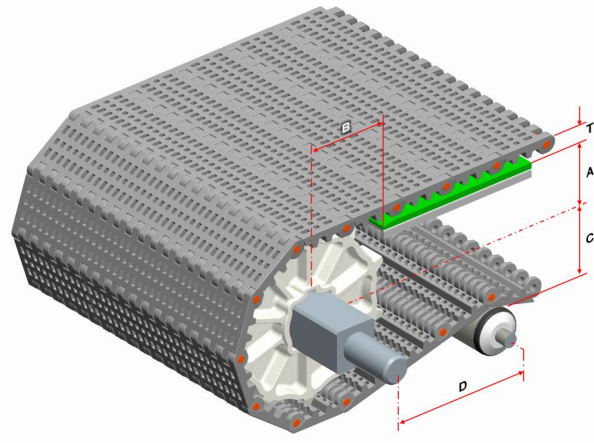

Conveyor Frame Dimensions

Unit : mm

No. Teeth	A (Min.)	B (Min.)	C (Max.)	D (Min.)	T
6	37.9	55.9	33.9	250	16
8	56	74	52	250	
9	63.5	81.5	59.5	250	
10	73	91	69	250	
12	88.4	106.4	84.4	300	
16	122	140	118	300	

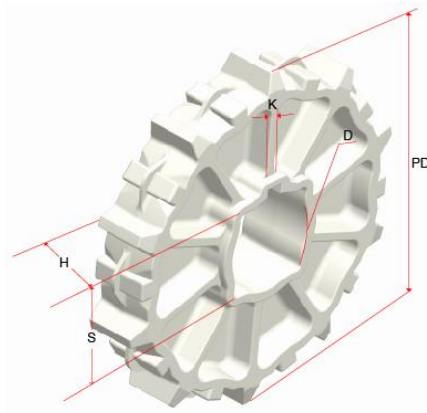
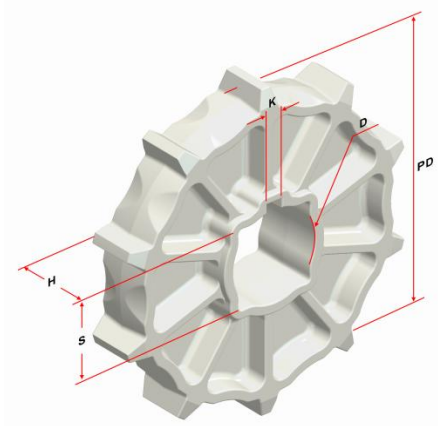

Sprocket Dimensions

Unit: mm

No. Teeth	PD	OD	S	D	H	K
6	101.60	91.8	38.1/40	25.4/30/35/40/45	30	8X8
8	132.75	128	38.1/40	25.4/30/35/40/44	37	8X8
9	148.53	143	38.1/40	30/32/45/51	35	8X8
10	164.39	162	38.1/40/50/60	25.4/30/35/40/45	35	8X8
12	196.28	192.8	38.1/40/60	45/47	37	8X8
16	260.39	260	38.1/40/60/63.5	--	46	--